

2557 Alarm Limit Switch

Float and tape driven switch for the indication of alarms or relays

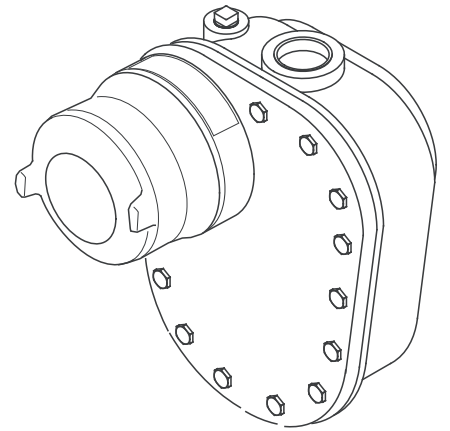

Copyright

All rights reserved. Printed in the United States of America.

Except as permitted under the United States Copyright Act of 1976, no part of this publication may be reproduced, stored in a retrieval system or transmitted in any form or by any means—electronic, mechanical, photocopying, recording or otherwise—without the prior written permission of the Publisher:

Varec, Inc.
5834 Peachtree Corners East
Norcross (Atlanta), Georgia 30092
Phone: (770) 447-9202
Fax: (770) 662-8939

Trademarks Acknowledged

Varec, Inc. recognizes all other trademarks. Trademarks of other products mentioned in this manual are held by the companies producing them.

FuelsManager®, TankView®, TacFuels® and Varec® are registered trademarks of Varec, Inc.

All other product and service names mentioned are the trademarks of their respective companies.

Disclaimer of Warranties

The contract between the Seller and the Buyer states the entire obligation of the Seller. The contents of this instruction manual shall not become part of or modify any prior or existing agreement, commitment or relationship between the Seller and Buyer. There are no express or implied warranties set out in this instruction manual. The only warranties that apply are those in the existing contract between the Seller and Buyer.

The 2557 Alarm Limit Switch (ALS) has not been tested by Varec under all possible operational conditions, and Varec may not have all the data relative to your application. The information in this instruction manual is not all inclusive and does not and cannot take into account all unique situations. Consequently, the user should review this product literature in view of his/her application. If you have any further questions, please contact Varec for assistance.

Limitations of Seller's Liability

In the event that a court holds that this instruction manual created some new warranties, Seller's liability shall be limited to repair or replacement under the standard warranty clause. In no case shall the Seller's liability exceed that stated as Limitations of Remedy in the contract between the Seller and Buyer.

Use of parts that are not manufactured or supplied by Varec voids any warranty and relieves Varec of any obligation to service the product under warranty. Varec recommends the use of only Varec manufactured or supplied parts to maintain or service Varec 2557 Alarm Limit Switches.

Terms of Use

The information provided in this document is provided "as is" without warranty of any kind. Varec, Inc. disclaim all warranties, either express or implied, including the warranties of merchantability and fitness for a particular purpose. In no event shall Varec, Inc. or its suppliers be liable for any damages whatsoever including direct, indirect, incidental, consequential, loss of business profits or special damages, even if Varec, Inc. or its suppliers have been advised of the possibility of such damages.

This manual is solely intended to describe product installation and functions and should not be used for any other purpose. It is subject to change without prior notice. This manual was prepared with the highest degree of care. However, should you find any errors or have any questions, contact one of our service offices or your local sales agent.

Safety Precautions

Read this manual carefully and make sure you understand its contents before using this product. Follow all instructions and safety guidelines presented in this manual when using this product. If the user does not follow these instructions properly, Varec cannot guarantee the safety of the system.

Note Comply with all applicable regulations, codes, and standards. For safety precautions, the user should refer to the appropriate industry or military standards.

Caution Electrical Hazard! Read and understand static and lightning electrical protection and grounding described in API 2003. Make certain that the tank installation, operation, and maintenance conforms with the practice set forth therein.

! Warning Striking the gaugehead with a metal object could cause a spark to occur. When removing or replacing the gaugehead in flammable or hazardous liquid storage areas, take necessary measures to protect the gaugehead from impact.

! Warning Volatile fumes may be present! Make certain that the tank is empty and not in service. Ensure that the tank has been leak and pressure tested as appropriate for the liquid to be stored. Observe appropriate safety precautions in flammable or hazardous liquid storage areas. Do not enter a tank that has contained hydrocarbons, vapors, or toxic materials, until a gas-free environment is certified. Carry breathing equipment when entering a tank where oxygen may be displaced by carbon dioxide, nitrogen, or other gases. Wear safety glasses as appropriate. Use a hard hat.

! Warning Sparks or static charge could cause fire or explosion! The mechanical connections between the guide cables, the float, the tape, and the gaugehead provide a resistance to ground that is adequate for the safe electrical drain of electrostatic charges that may accumulate in the tank and the product. Worker activity and worker clothing may accumulate electrostatic charges on the body of a worker. Care should be used in flammable environments to avoid the hazard.

! Warning Broken negator motor spring pieces can cause injury when the back cover of the gaugehead is removed! Whenever the back cover is removed, stand to one side as the last bolt is removed.

Contents

1	Introduction	1
1.1	Overview	1
1.2	Features	3
1.3	Functional and System Design	4
2	Installation	5
2.1	Unpacking	5
2.2	Storage Prior to Installation	5
2.3	Mounting on Varec Gaugeheads	5
2.4	General Safety Guidelines	6
2.5	Installation Safety Guidelines	6
2.6	Site Preparation Checklist	6
2.6.1	Wiring Limit Switches	7
2.7	Installation Guidelines	8
3	Calibration	9
3.1	Calibrating the 2557 ALS	9
3.1.1	To calibrate the 2557 ALS	9
3.2	Dials Used for Calibrating the 2557 ALS	13
3.2.1	English decimal dial used to measure feet on an outage gauge	13
3.2.2	English fractional dial used to measure inches on an outage gauge	14
3.2.3	Metric dial used to measure feet on an outage gauge	15
3.2.4	English decimal dial used to measure feet on an innage gauge	16
3.2.5	English fractional dial used to measure inches on an innage gauge	17
3.2.6	Metric dial used to measure feet on an innage gauge	18
4	Maintenance	19
4.1	Maintenance	19
4.1.1	Major System Assemblies and Components	19
4.2	Spare Parts and Mounting Adapters	20
4.2.1	Spare parts	20
4.2.2	Mounting adapters	20
5	Specifications	21
5.1	Environmental	21
5.2	Physical	21
5.3	Functional	21
5.4	Product Dimensions	22
6	Ordering Information	23
6.1	Order Codes	23

1 Introduction

This manual provides the information that is needed to install, maintain, and troubleshoot the Varec 2557 Alarm Limit Switch (ALS). Personnel performing installation or maintenance on this unit are assumed to be familiar with industry practices and instrumentation.

1.1 Overview

The 2557 ALS is a float and tape driven switch for the indication of alarms or relays. It is a cam-operated switch designed to mount directly to the Varec 2500/2520 Automatic Tank Gauge (ATG), refer to Figure 1-1 or to the Varec 6700 Liquid Level Indicator (LLI), refer to Figure 1-2. The 2557 ALS can be used to activate alarms or relays at any level selected by the user.

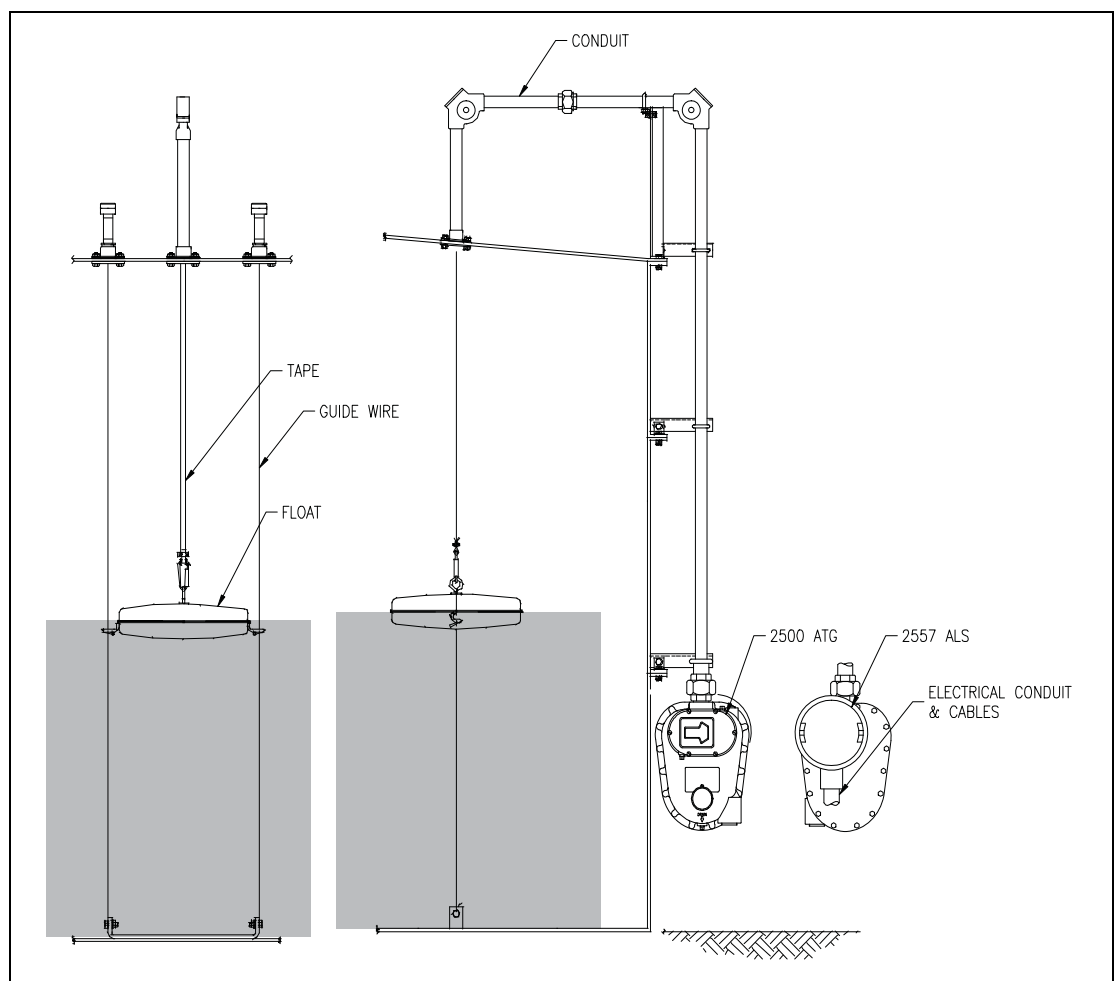

Figure 1-1: 2557 ALS Mounted on the 2500 ATG Diagram

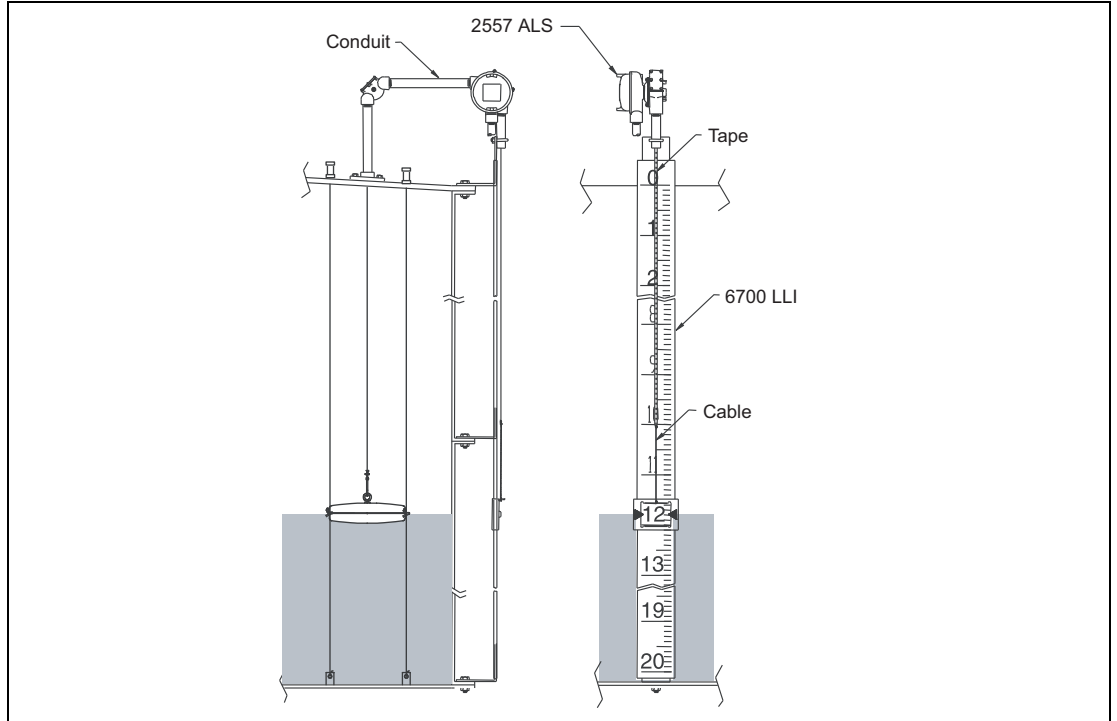

Figure 1-2: 2557 ALS Mounted on the 6700 LLI Diagram

1.2 Features

The following list outlines the features of the 2557 ALS:

- Mounts directly to the 2500 Automatic Tank Gauge (ATG)
- Mounts to the 6700 Liquid Level Indicator (LLI) with the Elbow Drive Accessory Kit
- Two SPDT cam-operated switches Underwriters Laboratories Incorporated (UL) approved
- Four and six SPDT cam-operated switches UL/Canadian Standards Association (CSA) approved
- Actuates alarms or relays
- Cast aluminum enclosure with an o-ring seal
- Switches operable in any desired sequence
- Independent adjustment of each switch in the unit

1.3 Functional and System Design

The primary issues to consider when selecting the options to be used involve the number of switch points to be initiated and the height of the tank. The switches may be used to operate lamps, relays, motors, or solenoid valves providing the load does not exceed ½ HP at 250 volts AC.

Typically, the unit must operate over the range denoted by the height of the tank. Therefore, in most cases, the range of the unit selected is equal to or greater than the tank height. An application involving the closure of limit switches upon reaching high and low limits of tank capacity would involve two switches – one for the high set point and one for the low. The requirement for additional measurement points involves the subsequent use of additional limit switches.

The range is determined by the gear ratio. The three ranges available – 16, 32, and 64 ft (4.87, 9.75, and 19.50 m) correspond to gear ratios of 25:1, 50:1, and 100:1 respectively. Each revolution of the drive shaft is equal to one foot of gauge travel. Therefore, with a 25:1 gear ratio, 25 ft (7.62 m) of gauge travel is equal to one revolution of the cam. The cam has 235 degrees of travel between switch points and 125 degrees of dwell. With a 25:1 gear ratio, 235 degrees results in 16 ft (4.87 m) of travel. 125 degrees is equal to 9 ft (2.7 m) of dwell. Varec strongly recommends using the 2557 with a redundant independent alarm system.



Figure 1-3: 2557 ALS with 4 Contacts

2 Installation

This chapter provides unpacking, storage, mounting, site preparation checklist, safety instructions, and installation guidelines for the 2557 ALS.

2.1 Unpacking

The 2557 ALS(s) are shipped fully assembled and ready for installation.

Place the shipping container on a secure bench before unpacking. Open the shipping container, taking care not to damage the contents. Carefully remove the alarm limit switch from the shipping container and place it on top of the bench. Inspect it for shipping damage. Report any damage to the carrier.

2.2 Storage Prior to Installation

If the alarm limit switch is to be stored prior to installation, it should be repacked in its shipping container and stored in a temperature and humidity controlled environment.

Caution! This equipment should be installed only by qualified personnel familiar with the installation instructions in this manual and in the *2500 Automatic Tank Gauge Installation and Operations Manual*.

2.3 Mounting on Varec Gaugeheads

The 2557 ALS is suitable for installation on 2500 ATG gaugeheads or on the gaugeheads of other manufacturers. This procedure provides instructions to mount the alarm limit switch on a 2500 ATG, as shown in Figure 1-1 on page 1.

2.4 General Safety Guidelines

The user shall follow safety guidelines provided by the Occupational Safety and Health Administration (OSHA) for additional protection. Informational may also be obtained from the following sources:

- National Electrical Code (NEC)
- National Fire Protection Association (NFPA)
- Instrument Society of America (ISA)
- Underwriters Laboratories Incorporated (UL)
- Canadian Standards Association (CSA)

When in doubt about the safety of an area, check with the local safety authorities. Always observe equipment labels and warning signs posted in the area.

2.5 Installation Safety Guidelines

This equipment should be installed only by qualified personnel familiar with the installation of float and tank gauging equipment.

Caution should be exercised when any area that is posted or otherwise assumed to contain hazardous gases. Always follow OSHA guidelines.

2.6 Site Preparation Checklist

Before you install the 2557 ALS on a mechanical float and tape gauge, you should ensure that:

1. The mechanical float gauge is operating correctly.
2. There is sufficient space around the mechanical gauge to install the 2557 ALS and accessories (such as the electrical conduit and cabling). Refer to Figure 1-1 on page 1.
3. You have the correct alarm limit switch/mechanical gauge adaptor, if required.
4. You have the correct field connections at the gaugehead ready to connect to the 2557 ALS.
5. You are in compliance with safety guidelines described in Section 2.4 and Section 2.5.

2.6.1 Wiring Limit Switches

Each of the SPDT limit switches, refer to Figure 5-1 on page 22, can be wired for Normally Open (NO) or Normally Closed (NC) operation by using the appropriated terminals (see Figure 2-1).

- Common and Normally Open
- Common and Normally Closed

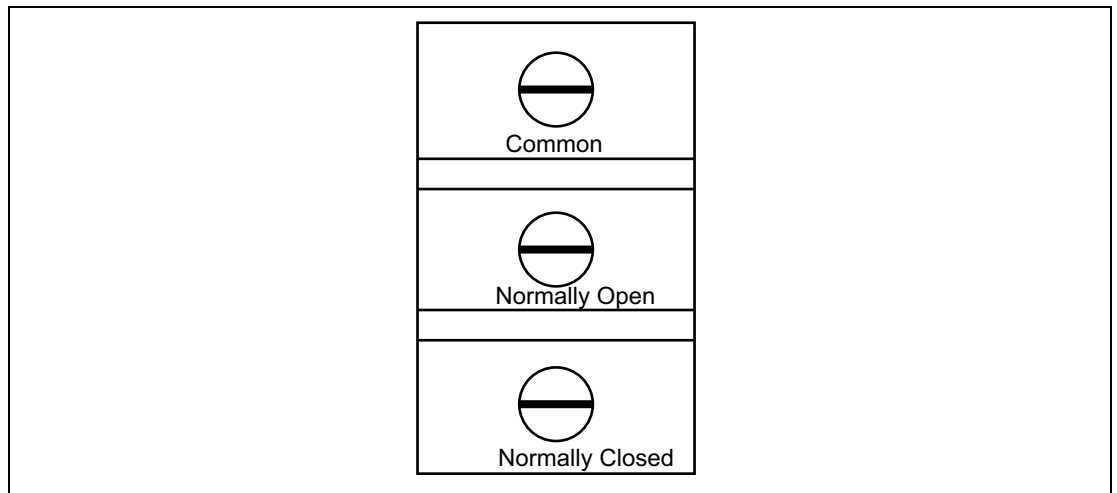

Figure 2-1: Limit Switch Contacts Diagram

2.7 Installation Guidelines

The 2557 ALS bolts directly to the back of the 2500 ATG (shown on front cover) or to the 2520 High Pressure Automatic Tank Gauge (ATG) fitted with a 2581 Oil Tight Adapter. Adapters are also available for mounting to other float gauges. When used with the 6700 LLI, the 2557 ALS is bolted to the elbow drive assembly located at the top of the tank. The elbow drive may also be used with the 2500 ATG and the 2557 ALS used as a secondary output.

3 Calibration

This chapter provides calibration instructions for the 2557 ALS.

3.1 Calibrating the 2557 ALS

Limit switches are cam-operated SPDT (Single-Pull, Double-Throw) switches that are used to turn on alarms or other devices when the tank contents reach a predetermined level. Two, four, or six limit switches are available with the 2557 ALS.

Limit switches are mounted directly to the 2500 ATG and are mechanically driven directly from the transmitter drive shaft. Each switch can be set to close or open at any level.

Note All limit switches are wired Normally Open (NO) at the factory. If Normally Closed (NC) contacts are required, the user must change the wiring at the switch. Refer to Section 2.6.1, "Wiring Limit Switches" on page 7.

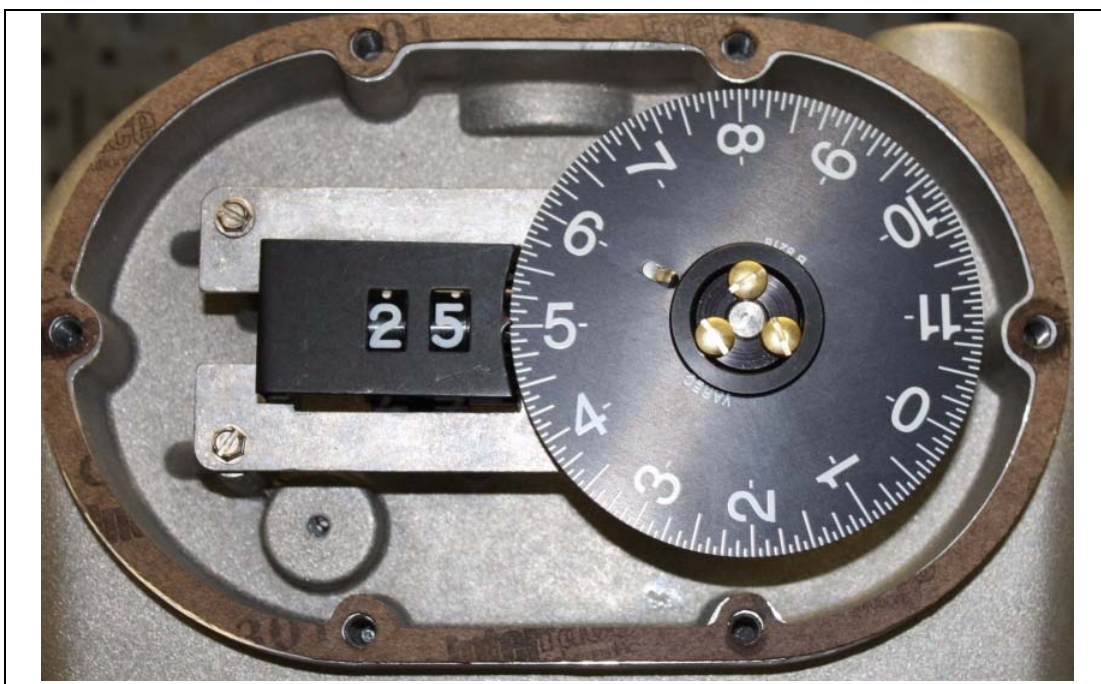

Figure 3-1: 2500 ATG with the Counter Cover Removed – Level Set to 25-5-1/16 Diagram

3.1.1 To calibrate the 2557 ALS

Note The above is an innage gauge.

Note One rotation equals one foot or 3/10 of a meter.

Note This process is similar for the metric system.

Calibrating the 2557 ALS

The following is an example of the parameters needed for the calibration of the 2557 ALS:

- Record the **Current Tank Level as 25-5-1/16**

- Set a **High Level at 35-6-1/16**
- Set a **Low Level at 5-0-0 feet**

To calibrate the 2557 ALS, do the following:

Warning! Do not apply power to the transmitter until all connections have been made and the cover of the transmitter has been replaced.

The limit switches normally are configured in arrays of 2 or 4 switches. To set these switches proceed as follows:

1. Remove power or obtain a hot work permit before removing the transmitter cover.
2. Determine which switch will be assigned to each specific limit. (High, Low, etc.)
3. Remove the back cover of the 2557 ALS.
4. Locate the pin drive on the sprocket sheave (see Figure 3-2).



Figure 3-2: Pin Drive at 8 o'clock on the Sprocket Sheave Diagram

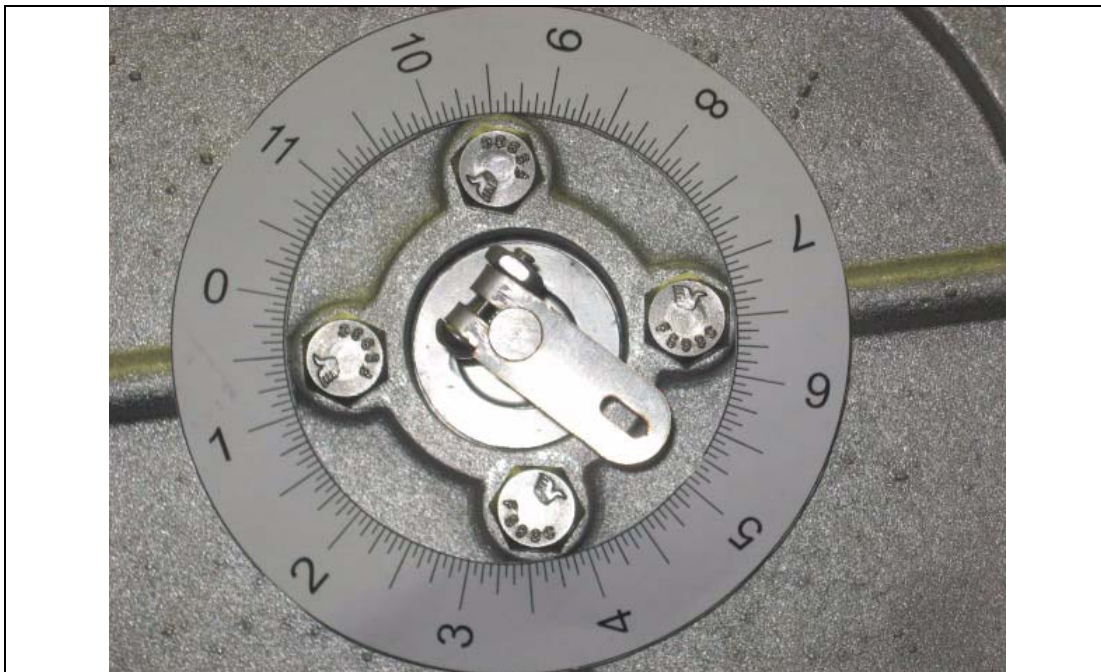

Figure 3-3: Slotted Drive on the Back Cover of the 2500 ATG at 4 o'clock

Note The pin drive is at 8 o'clock as shown in Figure 3-2 on page 10 and the slotted drive on the back cover is at 4 o'clock (the mirror of the pin drive) as shown in Figure 3-3.

5. Set the dial so the inches recorded in the first step are inline with the slotted drive. In this example it is $5 \frac{1}{16}$ inches. See Section 3.2, "Dials Used for Calibrating the 2557 ALS" on page 13 for more information about the dials. Cut out the appropriate dial for use in calibrating the 2557 ALS.

Set the tank's high level

Note A counter clockwise (CCW) rotation represents an increase in the level of the tank; a clockwise (CW) rotation represents a decrease in the level of the tank.

6. Turn the slotted drive CW to 0" so the dial is now at 25-0-0.
7. Calculate the number of rotations for the high level:
 - Setpoint = 35 feet
 - Start Level = 25 feet
 - Difference = 10 feet CCW
8. Rotate the slotted drive 10 turns CCW.
 - Tank Level is now 35-0-0
9. Add the sub feet by turning the slotted drive CCW to $6 \frac{1}{16}$ inches.
 - Tank Level is **35-6-1/16**
10. Set the appropriate cam so that the contact opens the desired switch.

Note When turning the slotted drive, note which direction the cam is turning because the switch must activate on the leading edge. If the contact opens too soon or too late, reverse (CW) the slotted drive 9 inches and readjust the cam and try again. This may take several tries to adjust the cam within one inch of the setpoint.

Reposition the tank level back to 25-5-1/16:

11. Rotate the slotted drive CW from 6 1/16 inches to 0 inches to get back to 35-0-0.
12. Rotate the slotted drive 10 turns CW.
 - Tank Level is now 25-0-0
13. Rotate the slotted drive CCW from 0 inches to 5 1/16 inches and the dial is back to 25-5-1/16.

Set the tank's low level

14. Rotate the slotted drive CW from 5 1/16 inches to 0 inches to get back to 25-0-0.
15. Calculate the number of rotations for the low level:
 - Setpoint = 5 feet
 - Start Level = 25 feet
 - Difference = -20 feet CW
16. Turn the slotted drive 20 turns CW.
 - Tank Level is now 5-0-0
17. Set the appropriate cam so that the contact opens the desired switch.

Note When turning the slotted drive, note which direction the cam is turning because the switch must activate on the leading edge. If the contact opens too soon or too late, reverse (CCW) the slotted drive 9 inches and readjust the cam and try again. This may take several tries to adjust the cam within one inch of the setpoint.

Reposition the tank level back to 25-5-1/16:

18. Rotate the slotted drive 20 turns CCW and the dial is back to 25-0-0.
 - Setpoint = 25 feet
 - Start Level = 5 feet
 - Difference = 20 turns CCW
19. Continue turning the slotted drive CCW to 5 1/16 inches and the dial is back to 25-5-1/16.

Note It is important to ensure that the pin is "IN" the slot.

3.2 Dials Used for Calibrating the 2557 ALS

Use the appropriate innage dials shown in Figures 3-4 through 3-6 if using an outage gauge (measuring what is not in the tank).

Use the appropriate outage dials shown in Figures 3-7 through 3-9 if using an innage gauge (measuring the level in the tank).

Note Innage gauges are the most common.

3.2.1 English decimal dial used to measure feet on an outage gauge

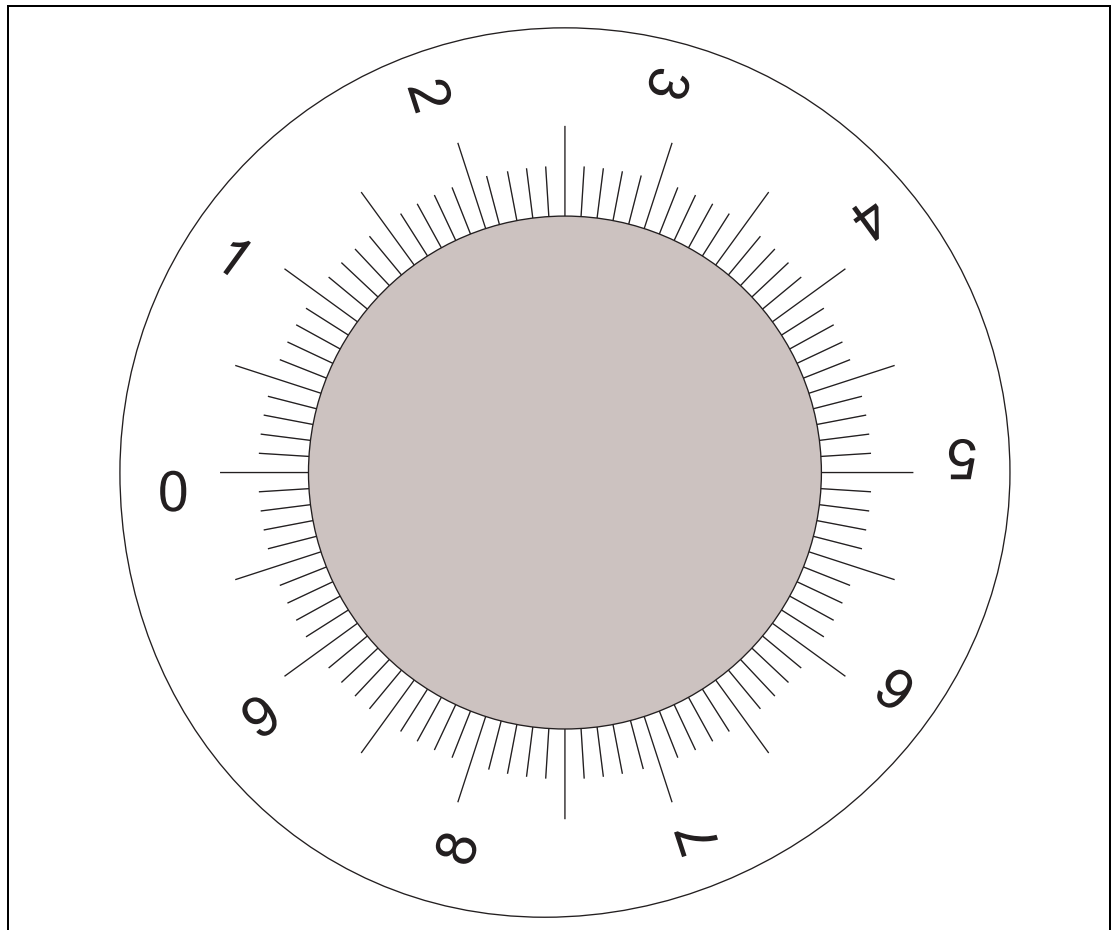

Figure 3-4: English Decimal Dial Used to Measure Feet on an Outage Gauge

3.2.2 English fractional dial used to measure inches on an outage gauge

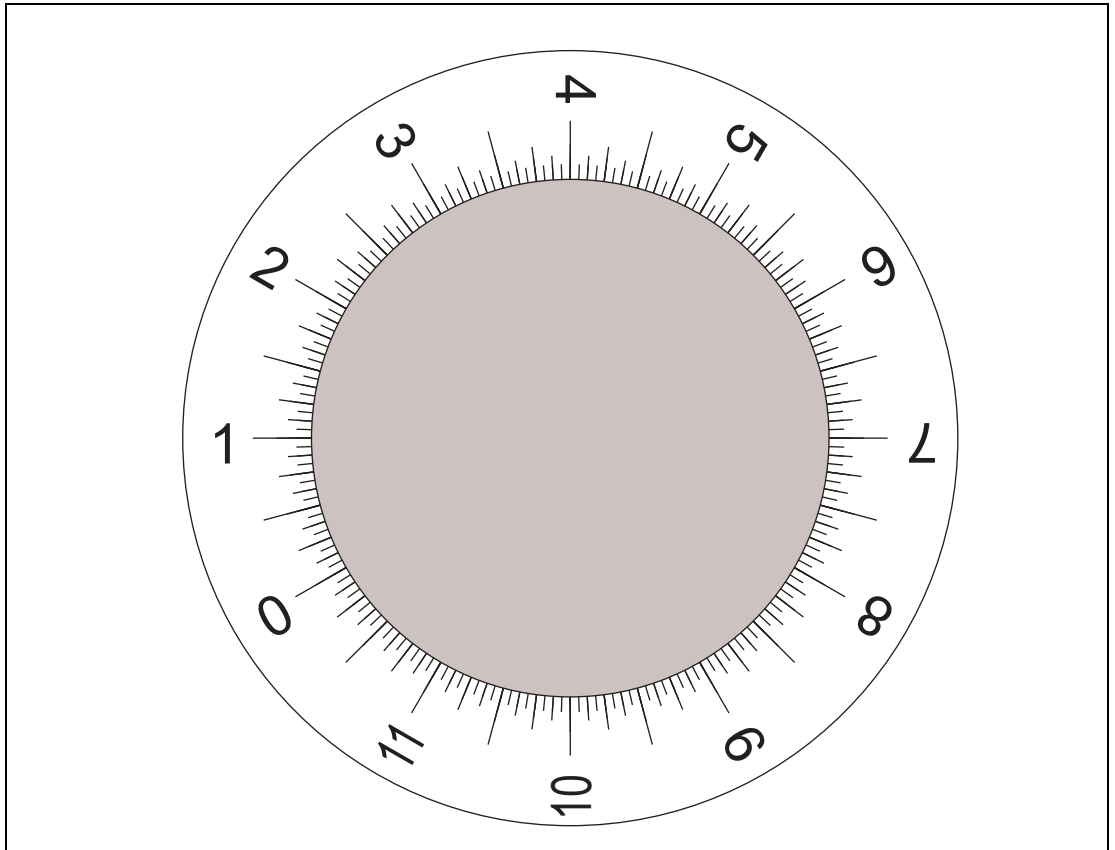

Figure 3-5: English Fractional Dial Used to Measure Inches on an Outage Gauge

3.2.3 Metric dial used to measure feet on an outage gauge

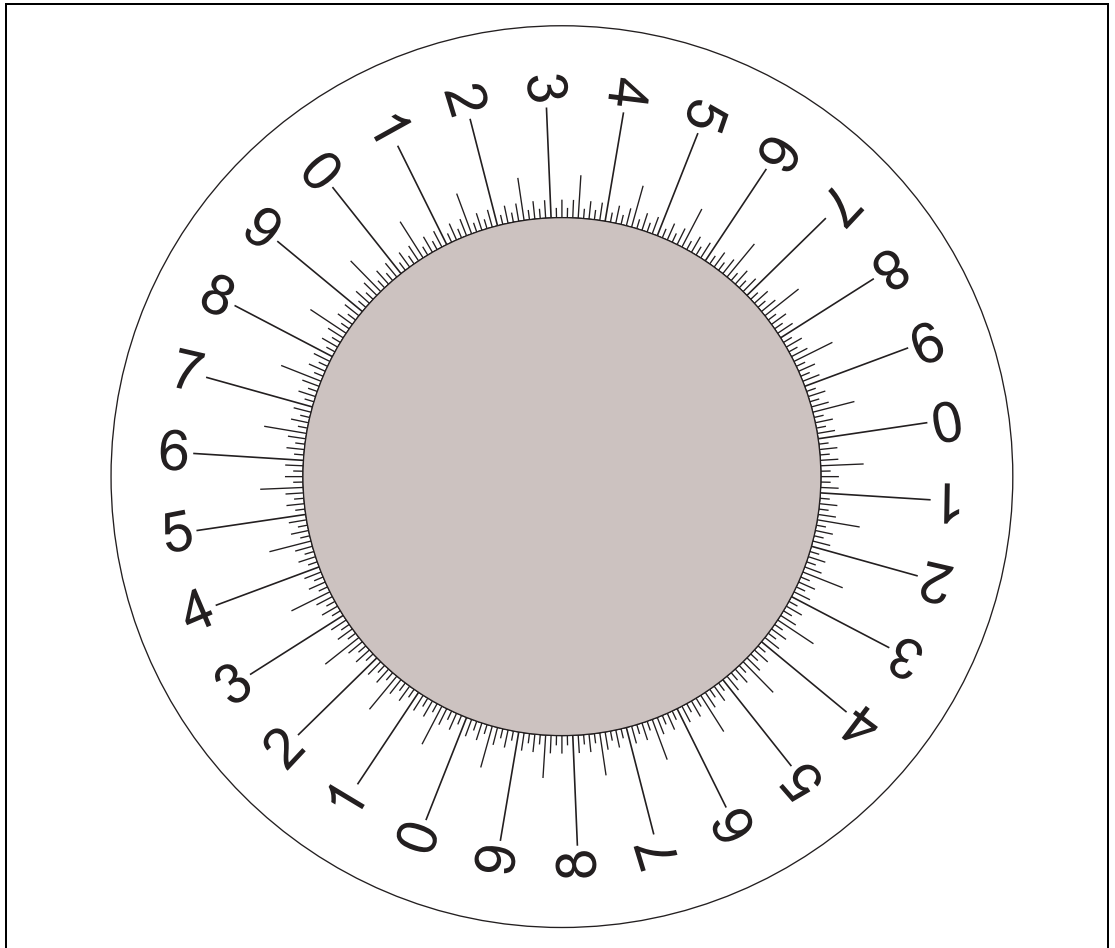

Figure 3-6: Metric Dial Used to Measure Feet on an Outage Gauge

3.2.4 English decimal dial used to measure feet on an innage gauge

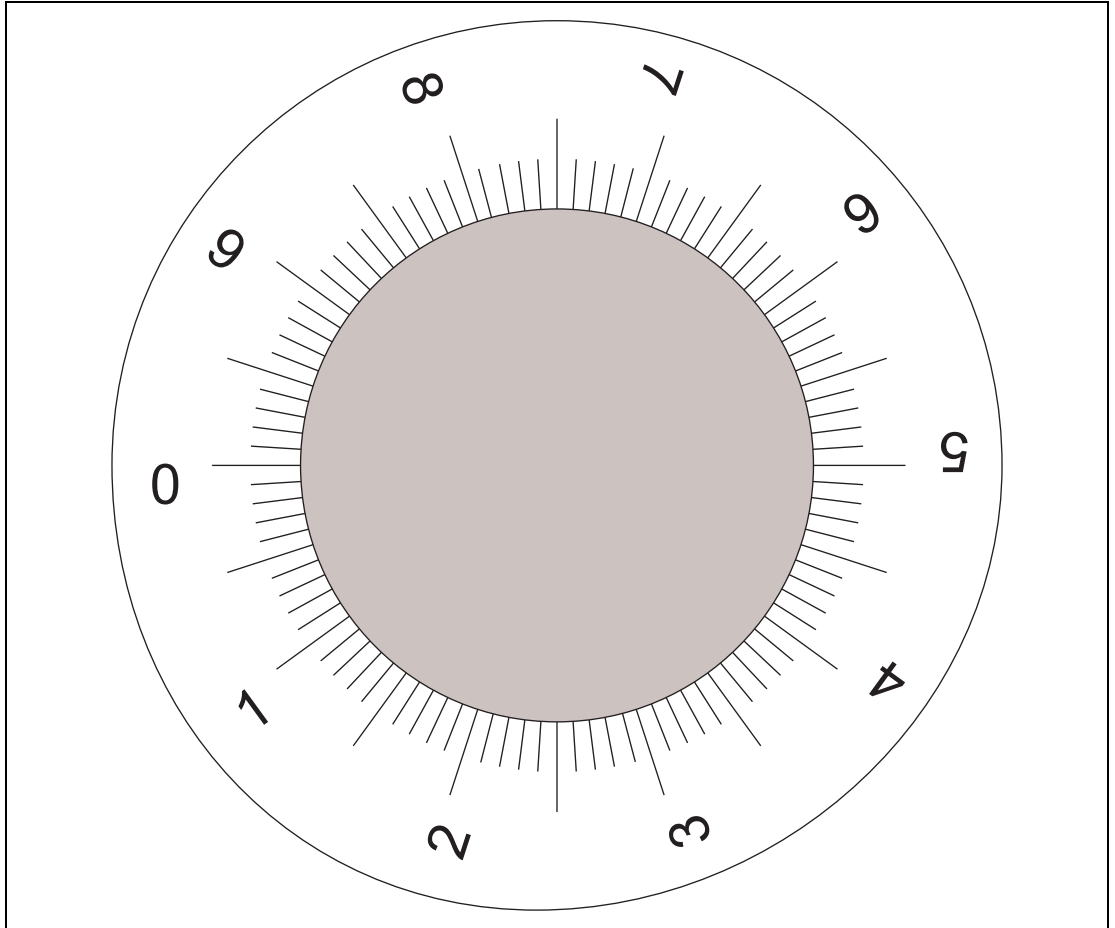

Figure 3-7: English Decimal Dial Used to Measure Feet on an Innage Gauge

3.2.5 English fractional dial used to measure inches on an innage gauge

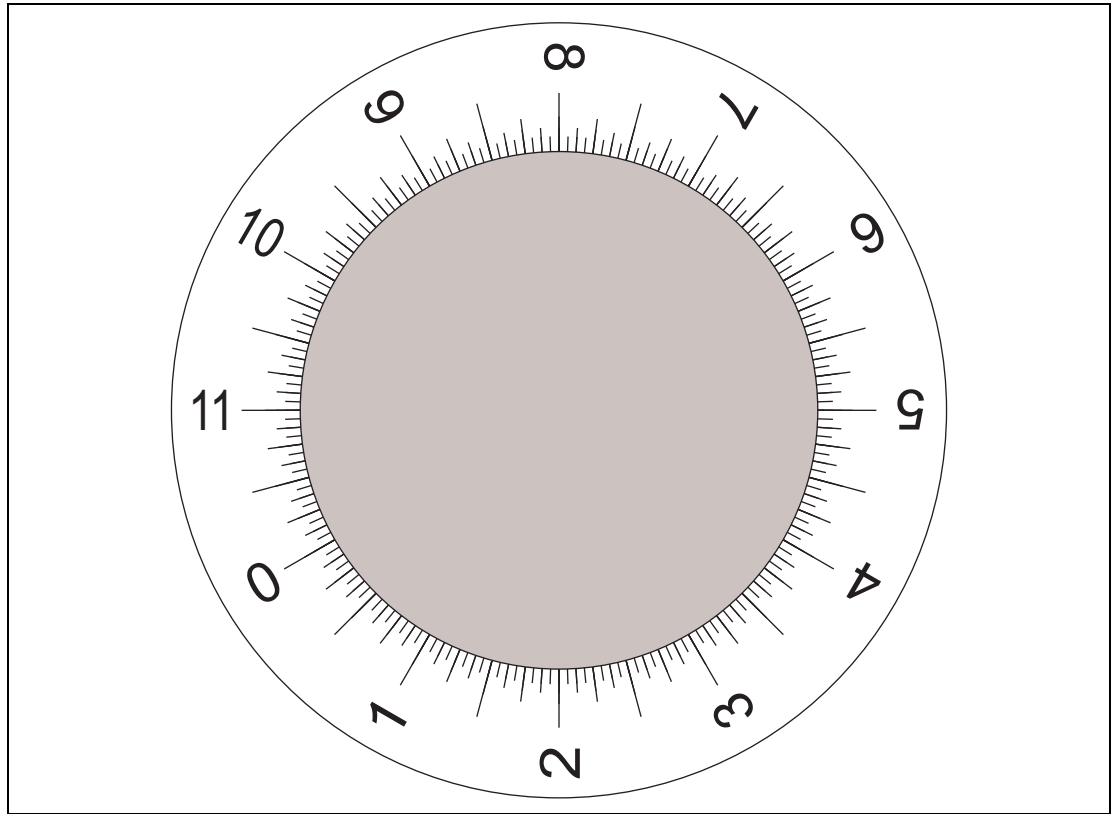

Figure 3-8: English Fractional Dial Used to Measure Inches on an Innage Gauge

3.2.6 Metric dial used to measure feet on an innage gauge

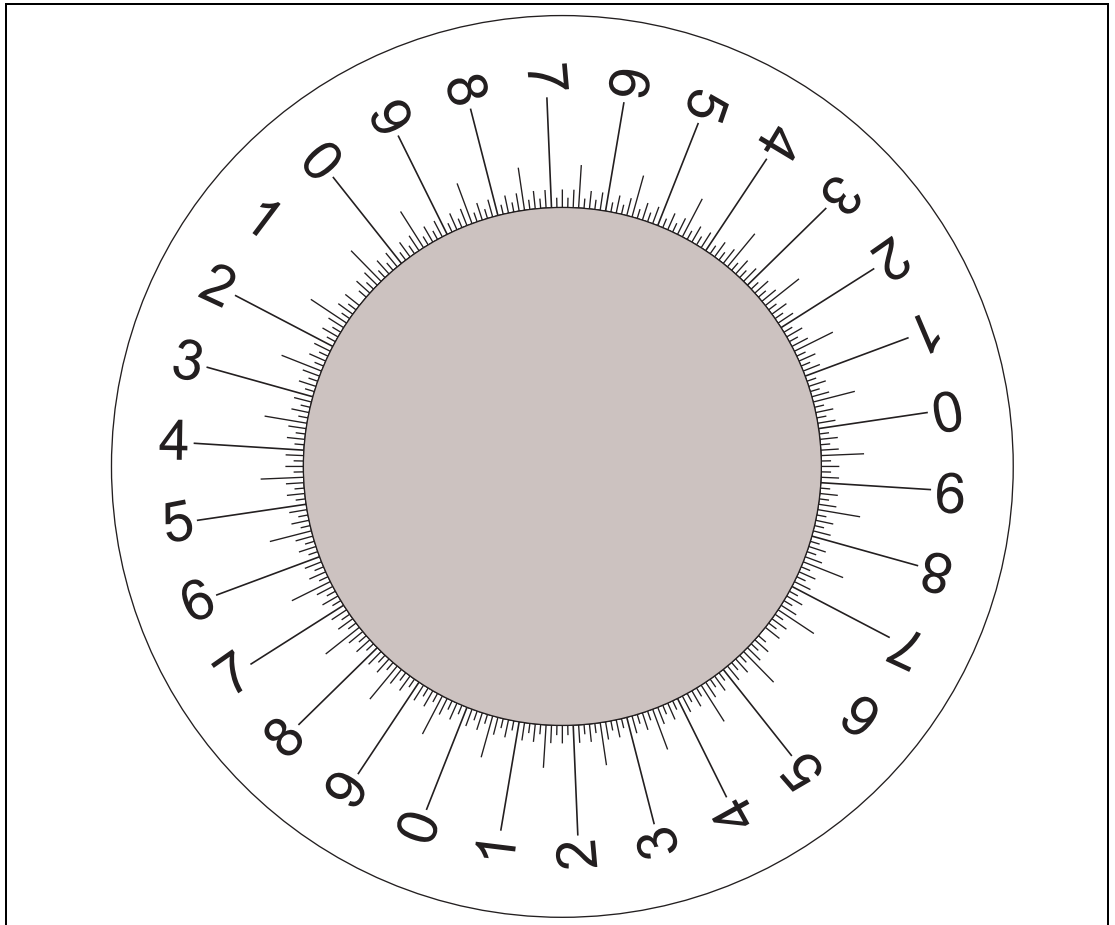

Figure 3-9: Metric Dial Used to Measure Feet on an Innage Gauge

4 Maintenance

4.1 Maintenance

Maintenance of the 2557 ALS consists of routine regular inspections under normal operating conditions. The user should make sure that the shaft connecting the ALS to the gaugehead is not binding.

Varec provides maintenance service contracts that provide regular periodic inspection and maintenance at substantial savings. Some repair tasks may require special tools.

4.1.1 Major System Assemblies and Components

The major system assemblies and components for the 2557 ALS are identified in Figure 4-1.

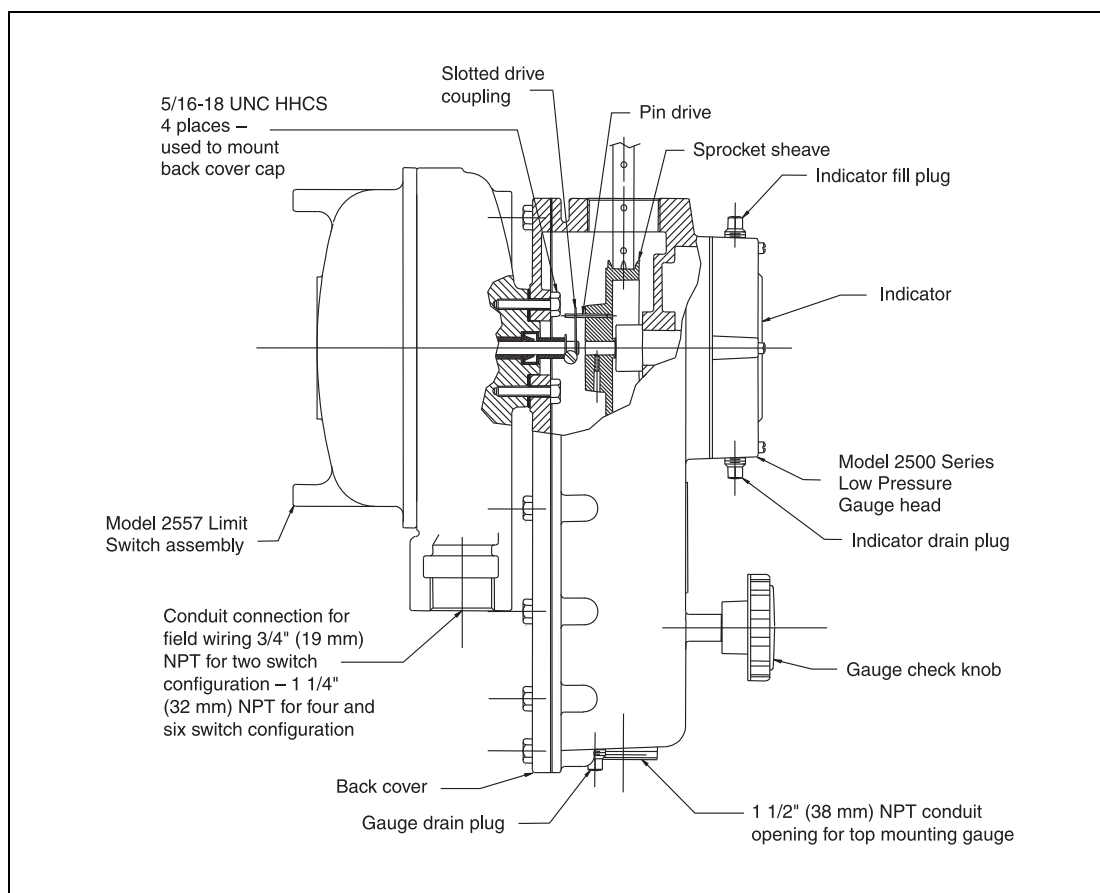

Figure 4-1: Assembly Diagram

4.2 Spare Parts and Mounting Adapters

4.2.1 Spare parts

This product requires factory servicing due to the critical alignments required when replacing spare parts – Please consult the factory.

Switch assemblies can only be replaced with same number of switches.

4.2.2 Mounting adapters

Table 4-1 lists the mounting adapters available for the 2557 ALS.

Part#	Tank gauge
13-05956-102	Adapter kit for mounting to Whessoe Varec/S&J/GPE 92513, 92514, 92020 and 92030
13-05956-202	Adapter kit for mounting to Whessoe Varec/S&J/GPE 92006, 2006

Table 4-1: Mounting Adapters

5 Specifications

The following specifications apply to the 2557 ALS over the normal (ambient) operating temperature range.

5.1 Environmental

Enclosure	Explosion proof: NEC Article 500 Class I, Group D
Electrical ratings	20 Amps 125, 250 or 480 V AC 10 Amps 125 Volts when controlling tungsten filament lamp loads on AC circuits 1 HP 115/125 V AC, 2 HP 230/250 V AC 1/2 Amp 125 V DC, 1/4 Amp 250 V DC

Note Field-Installed Conductors To Have Temperature Rating of 60 / 75°C (Cu.).

5.2 Physical

Material	Cast 356 aluminium base and cover
O-ring	Buna N (Nitrile)

5.3 Functional

Hazardous location approvals	UL, File No. E23827 – (2, 4, and 6 switches) CSA, File No. LR40894 – (4 and 6 switches)
-------------------------------------	--

Note Interposing relays may be required to maintain the circuit in pumping operations.

5.4 Product Dimensions

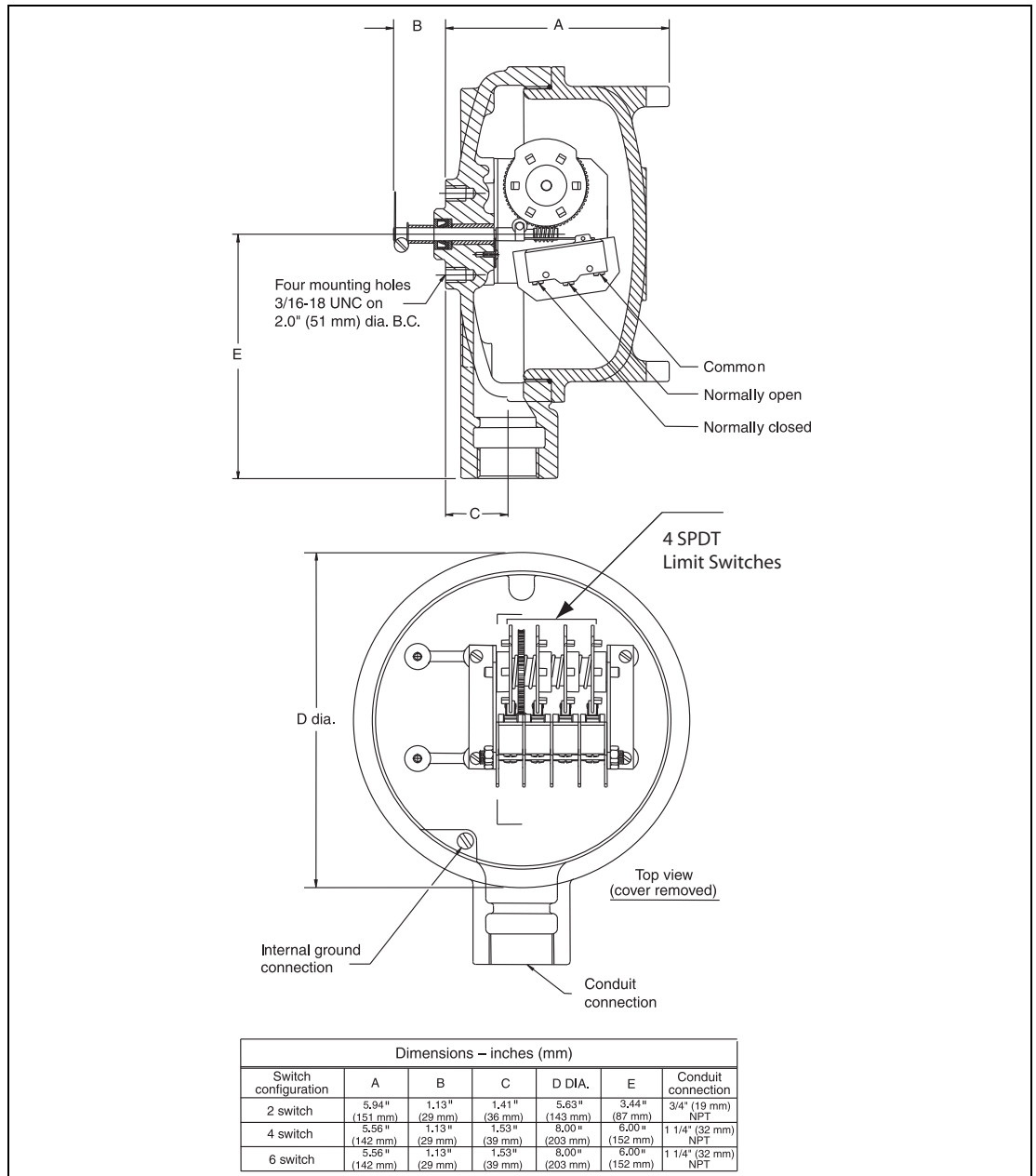

Figure 5-1: Product Dimensions Diagram

6 Ordering Information

6.1 Order Codes

Level Range	
A	Level Range: 0 to 32 feet/0 to 9.7 m
B	Level Range: 0 to 60 feet/0 to 18.3 m
G	Level Range: 0 to 16 feet/0 to 4.8 m

Type of Switches SPDT	
B	Two Switches SPDT UL Listed
D	Four Switches SPDT UL Listed + CSA Cert.
F	Six Switches SPDT UL Listed + CSA Cert.

2557 -		Complete product designation
--------	--	------------------------------

